

AXL-6-113

CORKSPORT DOWNPIPE 2007-2010 MAZDASPEED3

CORKSPORT

MAZDA PERFORMANCE BRAND
WWW.CORKSPORT.COM



⚠ WARNING: MAKE SURE VEHICLE IS COMPLETELY COOLED DOWN PRIOR TO STARTING INSTALLATION. EXHAUST SYSTEMS AND ESPECIALLY CATALYTIC CONVERTERS CAN GET HOT ENOUGH TO SERIOUSLY INJURE YOU. IF YOU'RE IN A HURRY, USE A FAN TO COOL OFF THE EXHAUST SYSTEM AND THE CATALYST.

⚠ WARNING: THOROUGHLY READ THE PRECAUTIONS AND INSTRUCTIONS THAT COME WITH YOUR FLOOR JACK AND JACKSTANDS AS WELL AS YOUR VEHICLE'S OWNERS MANUAL FOR APPROPRIATE JACKING METHODS AND JACKING / SUPPORT POINTS. ALWAYS DOUBLE UP SUPPORT ON A VEHICLE - JACK STANDS AND FLOOR JACK / ETC.

❓ NOTE: WHEN UNDER THE CAR, YOU SHOULD BE WEARING MECHANICS GLOVES OR SOME SORT OF HAND PROTECTION FROM CUTS - THE QUILTED ALUMINUM HEATSHIELDS ON THE SPEED3 HAVE DECEPTIVELY SHARP EDGES.

❓ NOTE: THESE INSTRUCTIONS WERE WRITTEN FOR REFERENCE ONLY AND THE USE OF A FACTORY SERVICE MANUAL IS RECOMMENDED. **PLEASE READ THESE INSTRUCTIONS THOROUGHLY PRIOR TO STARTING INSTALLATION.** THESE PRODUCTS ARE SOLD FOR USE OFF PUBLIC ROADS. ANY PRODUCT THAT REMOVES THE VEHICLE EMISSIONS COMPONENTS (LIKE CATALYTIC CONVERTERS) OR EFFECT FUNCTIONALITY OF VEHICLE EMISSION CONTROLS MUST NOT BE USED ON PUBLIC ROADS AND HIGHWAYS.





PART NUMBER:	MODEL	YEAR	TRIM
AXL-6-113	MAZDASPEED3	2007-2010	ALL
TIME ESTIMATE: 3-4 HOURS			
WRENCH RATING: 3.5/5			
TOOLING LIST:	FLATHEAD SCREWDRIVER SQUARE SHANK BEST.	PARTS LIST:	
3/8 DRIVE RATCHET	PENETRATING OIL (PB BLASTER/AEROKROIL)	CORKSPORT POWER SERIES DOWNPIPE FOR MS3	
3/8 DRIVE EXTENSIONS VARYING LENGTH	SILICONE SPRAY (WD-40)	2X M1 0X1 .25 70MM HEX BOLTS	
8MM SHORT SOCKET	ANTI SEIZE PASTE	2X M1 0X1 .25 80MM HEX BOLTS	
1 0MM SHORT SOCKET	TORQUE WRENCH	2X M1 0 SMALL FLAT WASHERS	
1 2MM LONG SOCKET	BREAKER BAR	2X M1 0 LARGE FLAT WASHERS	
1 4MM MEDIUM SOCKET		2X M1 0X1 .25 HEX NUTS	
1 7MM LONG SOCKET		2X 80MM DONUT GASKET	

COVER
PAGE

FOR HELP WITH INSTALLATION, CALL 360-260-CORK (2675)





INSTALLATION INSTRUCTIONS: CORKSPORT SHORT RAM INTAKE FOR 2010+ MAZDA 3

How THE INSTRUCTIONS WORK

TO BEST COVER ALL OF OUR CUSTOMERS EXPERIENCE LEVELS AND FAMILIARITY WITH THE SYSTEMS ON THEIR MAZDA, WE HAVE BROKEN OUR INSTRUCTIONS DOWN INTO NUMBERED STEPS, EACH OF WHICH HAS THE CORE INFORMATION IN THE HEADER WITH ADDITIONAL DETAIL AS NEEDED DEPENDING ON YOUR EXPERIENCE. IF YOU HAVE A HIGH LEVEL OF EXPERIENCE, YOU CAN JUST USE THE CHECKLIST BELOW AND THEN SKIP TO THE STEP NUMBER WHERE YOU NEED HELP OR ASSISTANCE. VIDEO ASSISTANCE MAY ALSO BE AVAILABLE FOR CERTAIN STEPS AND IS INDICATED BY THE HD ICON:  AREAS WHERE THERE IS A SAFETY CONCERN ARE INDICATED BY THE WARNING ICON:  CAUTIONARY AREAS (WHERE PARTS ARE FRAGILE, ETC) ARE INDICATED BY THE CAUTION ICON:  KEY TIPS ARE INDICATED WITH THE LIGHT BULB ICON: 

OVERVIEW/CHECKLIST:

THIS IS AN OVERVIEW OF EACH OF THE STEPS OF THE BUILD. YOU CAN USE THIS AS A REFERENCE AND A CHECKLIST AS YOU BUTTON UP THE WORK ON THE CAR.

- 1A) REMOVE INTERCOOLER COVER (10MM BOLTS)
- 1B) REMOVE CONNECTIONS / HOSE CLAMPS AT 4X HOSES ON INTERCOOLER AND BYPASS VALVE.
- 1C) DISCONNECT AND REMOVE 3X 12MM NUTS TO INTERCOOLER BRACKETS, REMOVE INTERCOOLER.  **INTERCOOLER FINS FRAGILE!**
- 1D) SPRAY W/ PENETRANT AND REMOVE 5X 8MM HEAT SHIELD BOLTS FROM EXHAUST MANIFOLD.  **EXHAUST MANIFOLD HOT, WEAR GLOVES.**
- 1E) SPRAY W/ PENETRANT AND REMOVE UPPER O2 SENSOR, UNCLIPPING HARNESS WHERE NECESSARY TO GET SLACK.
- 1F) SPRAY W/ PENETRANT AND REMOVE 3X 10MM UPPER DOWNPIPE HEATSHIELD BOLTS.
- 1G) SPRAY W/ PENETRANT AND REMOVE 3X 8MM LOWER DOWNPIPE HEATSHIELD BOLTS.
- 2A) SPRAY W/ PENETRANT AND REMOVE 5X 14MM DOWNPIPE NUTS FROM TURBO STUDS. MULTIPLE EXTENSIONS AND MEDIUM 14MM RECOMMENDED.
- 2B) REMOVE 10MM BOLT AND O2 SENSOR WIRING LOOM COIL FROM DOWNPIPE. RETAIN FOR LATER USE.
- 3A) PUT THE VEHICLE ON JACK STANDS AND A FLOOR JACK PER MANUFACTURERS SPECIFICATIONS AND JACK POINTS.  **REDUNDANT IS BEST - USE BOTH JACK STANDS AND SLIGHT PRESSURE ON THE FLOOR JACK.**
- 3B) REMOVE FRONT NON-LOAD BEARING CROSSMEMBER 4X 14MM BOLTS, 2X 14MM NUTS AND 1X 10MM BOLT.
- 3C) REMOVE 8X 12MM BOLTS FROM CHASSIS SUPPORT MEMBER UNDER SECONDARY CATALYST.
- 3D/E/F) REMOVE SECONDARY CATALYST FROM VEHICLE BY DISCONNECTING 14MM NUTS/BOLTS AND REMOVING FROM EXHAUST HANGERS.  **CATALYST FRAGILE!**
- 4A) UNPLUG O2 SENSOR CONNECTORS FROM HARNESS AND REMOVE SECONDARY O2 SENSOR.

INSTALLATION INSTRUCTIONS: CORKSPORT SHORT RAM INTAKE FOR 2010+ MAZDA 3

OVERVIEW/CHECKLIST (CONTINUED):

- 4B) REMOVE TWO 14MM BOLTS CONNECTING DOWNPIPE BRACKET TO ENGINE BLOCK. REQUIRES A LONG EXTENSION FOR EASIEST ACCESS. REMOVE DOWNPIPE FROM CAR (FROM THE BOTTOM).
- 4C) CHECK TURBO OUTLET GASKET FOR DAMAGE. REPLACE IF NECESSARY.
- 5A/B) INSTALL CORKSPORT DOWNPIPE INTO UNDERSIDE OF CAR, START FORWARD LOWER NUT ONTO STUD FIRST AND TORQUE TO 39-46 FT LB OF TORQUE. INSTALL OTHER FOUR NUTS AND TIGHTEN TO 39-46 IN A CRISS-CROSS PATTERN ENDING WITH LOWER MIDDLE BOLT.
- 5C) INSTALL SMALL FLAT WASHERS AND LONG 10MM BOLTS (70MM FOR USE WITH CORKSPORT RACEPIPE, 80MM FOR FACTORY CATALYST) THROUGH DOWNPIPE FLANGE FACING REARWARD.
- 5D) INSTALL LOWER O2 SENSOR AND RECONNECT CONNECTORS TO HARNESS. USE ANTI-SEIZE TO MAKE REMOVAL EASIER NEXT TIME.
- 5E) INSTALL UPPER O2 SENSOR AND RECONNECT CONNECTORS TO HARNESS. INSTALL PREVIOUSLY REMOVED COIL RETAINER TO LOCATION ON FIREWALL AND FEED WIRE THROUGH COIL. USE ANTI-SEIZE HERE ALSO.
- 6A/B/C) REINSTALL CATALYST PIPE USING PREVIOUSLY REMOVED SPRINGS ON CONNECTION TO DOWNPIPE, FOLLOWED WITH LARGE FLAT WASHERS AND NUTS (TIGHTENED TO 1MM GAP IN SPRINGS, DOUBLED UP FOR LOCKING). USING FACTORY FASTENERS AT REAR AND REINSTALL HANGERS.
- 6D) REINSTALL THE FRONT CHASSIS BRACE (4X 14MM HEAD HEX BOLTS, 2X 14MM NUTS, 1X 10MM). TORQUE THE 14MM BOLTS & NUTS TO 22-28 LB FT. TIGHTEN THE 10MM HAND TIGHT (~10 LB FT).
- 6E) REINSTALL CENTER CHASSIS BRACE (8X 12MM BOLTS) AND TORQUE TO 22-28 LB FT.
- 7A) REINSTALL THE LOWER AND UPPER EXHAUST MANIFOLD HEAT SHIELDS. APPLY ANTI-SEIZE AND TORQUE TO ~10 FT LB.
- 7B) REINSTALL THE INTERCOOLER INTO THE HOT AND COLD CHARGE COUPLERS AND OVER THE MOUNTING STUDS. TIGHTEN COUPLER HOSE CLAMPS. INSTALL 12MM NUTS OVER STUDS AND TIGHTEN TO ~20 FT LB OF TORQUE.
- 7C) INSTALL RECIRCULATION VALVE HOSE AND REINSTALL HOSE CLAMP. INSTALL RECIRCULATION VACCUM LINE AND REINSTALL HOSE CLAMP.
- 7D) INSTALL INTERCOOLER COVER AND REINSTALL TWO 10MM HEX HEAD BOLTS. TIGHTEN TO HAND TIGHT. **DO NOT OVERTIGHTEN.**
- 8A) TAKE VEHICLE DOWN OFF OF THE JACKSTANDS PER MANUFACTURERS RECOMMENDATION AND START VEHICLE, CHECK FOR EXHAUST LEAKS. IF LEAKS ARE PRESENT - CHECK TO MAKE SURE DONUT GASKETS ARE CONCENTRIC WITH THEIR MATING FLANGE AND NOT OVERTIGHTENED.

INSTALLATION INSTRUCTIONS: CORKSPORT POWER SERIES DOWNPIPE 2010+ MAZDASPEED3

1: GET TO THE DOWNPIPE.

NOW THAT YOU'VE READ THROUGH ALL OF THE INSTRUCTIONS, GO AHEAD AND POP YOUR HOOD AND WE'LL REMOVE ALL OF THE ITEMS NECESSARY TO GET TO THE DOWNPIPE FROM THE TOP SIDE OF THE ENGINE.

⚠ THE ENGINE COMPARTMENT IS **HOT** AND YOU MUST TAKE CARE TO PROTECT YOURSELF WHEN WORKING AROUND IT. IT IS EASIER TO GET THE BOLTS OUT OF THE HEATSHIELD, ETC WHEN THE ENGINE IS STILL WARM, BUT IF YOU HAVE BEEN DRIVING IT HARD, YOU SHOULD LET IT COOL DOWN PRIOR TO WORKING ON THE VEHICLE. ALSO, **PROTECT YOURSELF WITH APPROPRIATE MECHANICS GLOVES WHILE WORKING AROUND EXHAUST.** BURNS SUCK.

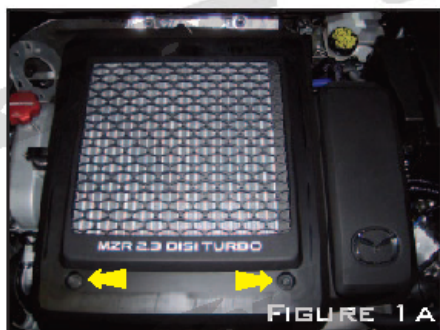

FIGURE 1 A

A. REMOVE THE TWO 10MM HEX BOLTS HOLDING THE INTERCOOLER COVER TO THE INTAKE MANIFOLD AS SHOWN IN FIGURE 1 A. SLIDE THE INTERCOOLER COVER OFF THE BACK OF THE INTERCOOLER AND OUT OF THE ENGINE COMPARTMENT.

? THE INTERCOOLER FINS ARE MADE OF THIN ALUMINUM AND CAN BE EASILY DAMAGED OR BENT. USE CARE NOT TO LEAN ON THE INTERCOOLER OR DAMAGE THE FINS.

B. LOOSEN THE HOSE CLAMPS ON THE INLET AND OUTLET OF THE TOP MOUNT INTERCOOLER AS SHOWN IN FIGURE 1 B, ITEMS 1 & 2. THE CLAMPS ARE CONVENIENTLY GLUED ONTO THE HOSES SO THEY WON'T ROTATE, YOU JUST HAVE TO LOOSEN THEM. USE YOUR NEEDLE NOSE PLIERS TO LOOSEN THE HOSE CLAMPS ON THE RECIRCULATION VALVE (SHOWN IN FIGURE 1 B, ITEMS 3 & 4 AND PULL THE RECIRC HOSES FREE OF THE VALVE.)

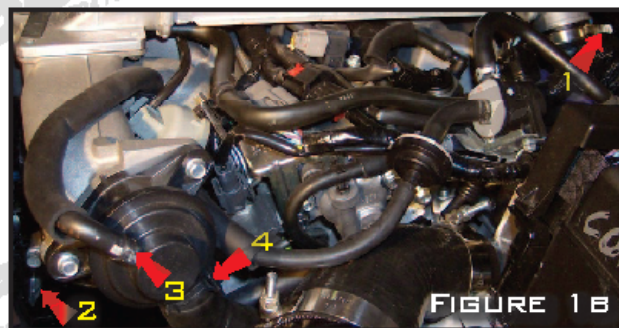

FIGURE 1 B

C. REMOVE THREE 12MM INTERCOOLER MOUNTING BOLTS SHOWN IN FIGURE 1 C.



FIGURE 1 C

PULL THE INTERCOOLER UP OFF OF THE STUD AT THE REAR OF THE ENGINE COMPARTMENT, THEN ROTATE IT OFF OF THE HOT-CHARGE HOSE AT THE BACK OF THE ENGINE COMPARTMENT. PULL THE INTERCOOLER OF THE TWO FRONT STUDS AND OUT OF THE COLD-CHARGE HOSE IN THE FRONT OF THE ENGINE COMPARTMENT. PLACE THE INTERCOOLER IN A SAFE PLACE WHERE THE FINS WILL NOT BE DAMAGED.

D. APPLY PENETRATING OIL, ALLOWING TO SOAK FOR A FEW MINUTES AND REMOVE ALL FIVE 8MM HEX HEAD BOLTS FROM THE UPPER HEAT SHIELD ON THE EXHAUST MANIFOLD, MARKED WITH RED ARROWS ON FIGURE 1 D. REMOVE THE HEAT SHIELD FROM THE VEHICLE.

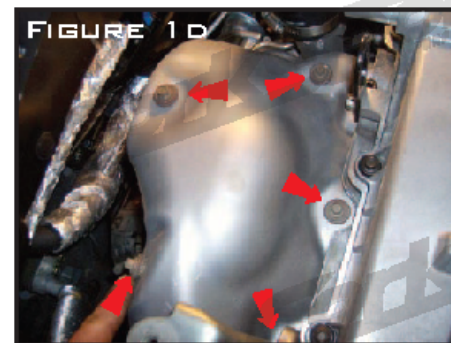

FIGURE 1 D

E. APPLY PENETRATING OIL, ALLOWING TO SOAK FOR A FEW MINUTES AND REMOVE UPPER O2 SENSOR, OUT OF THE EXHAUST MANIFOLD USING AN O2 SENSOR WRENCH. ONCE IT BREAKS FREE, RESPRAY IT AND TURN IT BACK IN, THEN BACK OUT TO ALLOW PENETRATING SPRAY TO INFILTRATE ALL OF THE THREADS. **?** MAKE SURE NOT TO TWIST THE WIRING HARNESS UP WHEN REMOVING THE SENSOR. YOU CAN DISCONNECT IT AT THE PLUG IF NECESSARY, BUT THERE IS PLENTY OF SLACK TO REMOVE THE SENSOR AND AVOID TWISTING THE CABLE.

INSTALLATION INSTRUCTIONS:

CORKSPORT POWER SERIES DOWNPIPE 2010+ MAZDASPEED3

1: GET TO THE DOWNPIPE (CONTINUED).

F. REMOVE THE THREE 10MM HEX HEAD BOLTS FROM THE UPPER DOWNPIPE HEATSHIELD AND REMOVE THE HEATSHIELD.

G. REMOVE THE THREE 8MM HEX HEAD BOLTS FROM THE LOWER DOWNPIPE HEATSHIELD AND REMOVE THE HEATSHIELD. AGAIN, IF THE DOWNPIPE IS STILL HOT, YOU NEED TO WEAR HAND PROTECTION AS THESE ARE ON THE UNDERSIDE OF THE PIPE AND REQUIRE YOU TO LOCATE THEM BY FEEL.

2: REMOVING THE FACTORY DOWNPIPE (TOP SIDE)

A. SPRAY PENETRATING OIL ON THE FIVE 14MM HEADED NUTS (SHOWN W/ RED ARROWS IN FIGURE 2A) THAT HOLD THE FACTORY DOWNPIPE TO THE TURBOCHARGER. LET THEM SOAK FOR SEVERAL MINUTES THEN REMOVE THE NUTS. THEY ARE A FACTORY LOCKING STYLE NUT SO THEY MAY BE DIFFICULT TO REMOVE. THIS IS WHERE A MEDIUM LENGTH 14MM SOCKET AND A BREAKER BAR, UNIVERSAL JOINT, 4", 6", 8" AND 12" EXTENSIONS COME IN HANDY. VARIOUS COMBINATIONS OF THESE ITEMS WILL GET YOU GOOD LEVERAGE TO BRAKE THE NUTS FREE AND PLENTY OF ROTATION ON YOUR RATCHET.

 THE STUDS MAY EXTRACT FROM THE TURBOCHARGER INSTEAD OF THE NUTS COMING OFF OF THE STUDS. IT IS POSSIBLE TO RE-USE THE STUDS W/ NUTS ATTACHED, BUT IT IS RECOMMENDED THAT YOU USE AT LEAST ONE STUD TO RE-HANG THE NEW DOWNPIPE. PREFERABLY TWO STUDS. IF ALL FIVE OF YOUR STUDS UNTHREAD OUT OF THE TURBOCHARGER, YOU WILL NEED MAZDA PART NUMBERS L33E-1 3-1 46 AND L33E-1 3-1 46A OR AN EQUIVALENT STUD FROM A FASTENER OR HARDWARE STORE. STAINLESS STEEL IS HIGHLY RECOMMENDED.

IF ALL OF THE STUDS UNTHREAD FROM THE TURBINE HOUSING, YOU WILL WANT TO KEEP ONE IN TO HOLD THE DOWNPIPE WHILE YOU ARE UNDER THE VEHICLE, IF THE STUDS REMAIN, THE DOWNPIPE WILL HANG ON THE STUDS.

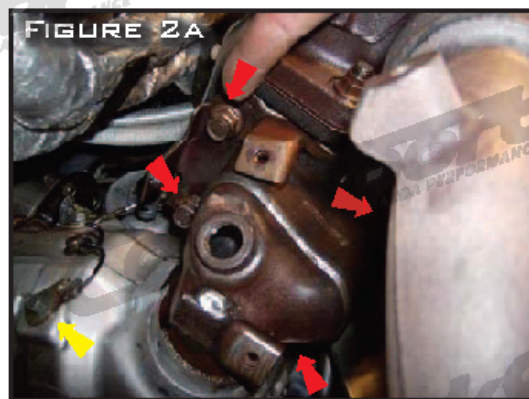

B. REMOVE 10MM HEX HEAD BOLT AND 02 SENSOR WIRING HARNESS LOOM FROM DOWNPIPE SHOWN WITH YELLOW ARROW IN FIGURE 2A. IT WILL BE REUSED TO SECURE THE FACTORY 02 SENSOR WIRING HARNESS.

3: REMOVING FACTORY CROSSMEMBERS, CAT PIPE.

A. USING A FLOOR JACK AND JACKSTANDS, BRING THE FRONT OF THE CAR UP IN THE AIR ENOUGH TO ACCESS THE UNDERSIDE OF THE CHASSIS. READ AND FOLLOW ALL FACTORY OWNERS MANUAL RECOMMENDATIONS FOR JACKING POINTS AS WELL AS THE INSTRUCTIONS FOR THE JACK AND JACKSTAND. THE VEHICLE SHOULD BE ON A HARD LEVEL SURFACE AS WELL. ASPHALT DOES NOT COUNT - THE JACKSTANDS CAN SINK INTO THE ASPHALT AND DROP THE CAR.

B. REMOVE THE FRONT CHASSIS CROSSMEMBER BY REMOVING THE FASTENERS SHOWN IN FIGURE 3B: 4X 14MM BOLTS, 2X 14MM NUTS AND 1 X 10MM BOLT HOLDING BRAKE LINE SHIELD TO THE CHASSIS.

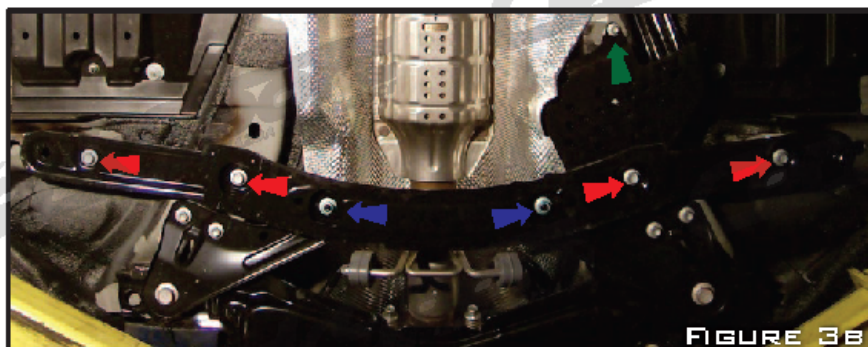

FIGURE 3B

FOR HELP WITH INSTALLATION, CALL 360-260-CORK (2675)

INSTALLATION INSTRUCTIONS: CORKSPORT POWER SERIES DOWNPIPE 2010+ MAZDASPEED3

3: REMOVING CROSSMEMBERS, CATALYST (CONTINUED)

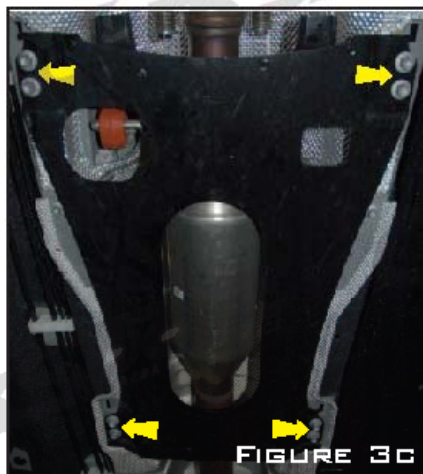

FIGURE 3C

C. REMOVE 8X12MM BOLTS FROM CENTER CHASSIS SUPPORT MEMBER SHOWN IN FIGURE 3C. SLIDE THE SUPPORT MEMBER HOOKS OUT OF THE FLOOR PAN AND SET ASIDE.

D. SPRAY CATALYST PIPE FASTENERS WITH PENETRATING SPRAY AND HANGERS WITH SILICONE SPRAY. REMOVE 14MM LOCKING NUTS SHOWN IN FIGURE 3D, ITEM A FROM SPRING LOADED STUDS ON THE REAR FLANGE OF THE CATALYST PIPE WITH A 14MM SOCKET AND 3/8" DRIVE RATCHET. THESE ARE EXTREMELY TIGHT. REALISTICALLY, YOU'LL PROBABLY END UP UNTHREADING THE STUDS OUT OF THE WELD NUTS ON THE FACTORY CATPIPE.

E. REMOVE 2X14MM SPRING LOADED HEX BOLTS SHOWN IN FIGURE 3D, ITEM B FROM THE FRONT FLANGE CONNECTING THE FACTORY CATPIPE TO THE FACTORY DOWNPIPE. SET THE SPRINGS ASIDE AS THEY WILL BE REUSED.

F. THE FACTORY CATALYST PIPE IS NOW TETHERED TO THE CHASSIS ONLY BY THE EXHAUST HANGER BUSHINGS SHOWN IN FIGURE 3D, ITEM C. PUSH THE ENTIRE CATPIPE TO ONE SIDE TO GAIN AS MUCH REACH ON PUSHING ONE OF THE BUSHINGS OFF OF THE CATPIPE. PRESS THAT BUSHING OFF OF THE HANGER BY HAND AS SHOWN IN FIGURE 3A (SEE VIDEO DEMONSTRATION HERE: [HTTP://WWW.YOUTUBE.COM/WATCH?V=G3PABZET8H4](http://www.youtube.com/watch?v=g3pabzet8h4)) THIS IS DIFFICULT, YOU HAVE TO REALLY YARD ON THESE TO GET THEM OFF. IF THEY FEEL LIKE THEY ARE STICKING TO THE HANGER, SPRAY MORE WD-40 OR SILICONE SPRAY. ONCE YOU GET ONE OF THEM OFF, THE OTHER SLIDES OFF EASILY. REMOVE THE CATALYST PIPE FROM THE VEHICLE.

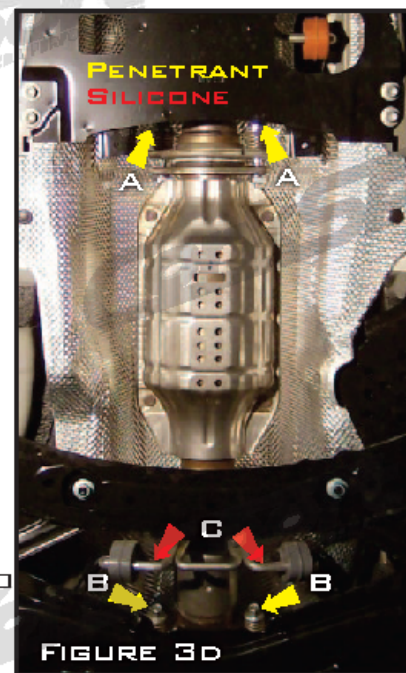

FIGURE 3D

⚠ BE CAREFUL WITH THE CATALYST - IT CONTAINS A CERAMIC HONEYCOMB SUBSTRATE INSIDE WHICH CAN BE CRACKED IF IT IS DROPPED.

4. REMOVAL OF THE DOWNPIPE.



FIGURE 4A

A. FOLLOW THE O2 SENSOR HARNESSSES AND UNPLUG BOTH O2 SENSOR CONNECTORS SHOWN IN FIGURE 4A FROM THE MAIN HARNESS. THE UPPER O2 SENSOR IS A 2 PLUG STYLE WITH ONE BLACK AND ONE GREY CONNECTOR. THE LOWER O2 SENSOR IS A SINGLE GREY PLUG. ONCE THE LOWER O2 SENSOR IS UNPLUGGED

REMOVE IT FROM THE FACTORY DOWNPIPE. MAKE SURE THE O2 WIRES ARE COMPLETELY FREE BEFORE REMOVING THEM FROM THE VEHICLE.

B. REMOVE THE TWO 14MM HEADED BOLTS WHICH HOLD THE DOWNPIPE BRACKET TO THE ENGINE. THESE TWO BOLTS ARE ON THE PASSENGER UPPER SIDE OF THE BRACKET, AND CONNECT BE SEEN FROM BELOW OR ABOVE WITH THE CATALYST IN THE CAR. YOU CAN GET A NEARLY STRAIGHT CONNECTION ON IT WITH A LONG EXTENSION COMING IN FROM ABOVE AND BEHIND THE TRANSMISSION CROSS MEMBER. REMOVE THE BRACKET FROM THE VEHICLE. REMOVE THE FACTORY DOWNPIPE OUT THE BOTTOM OF THE CAR.

INSTALLATION INSTRUCTIONS: CORKSPORT POWER SERIES DOWNPIPE 2010+ MAZDASPEED3

4. REMOVAL OF THE DOWNPIPE (CONTINUED).

C. CHECK AND MAKE SURE THE STOCK TURBO TO DOWNPIPE BASKET IS IN GOOD SHAPE. IF IT HAS DAMAGE OR LOOKS LIKE IT HAS BEEN LEAKING REPLACE IT. FACTORY PART NUMBER L3F2-1 3-490.

5. INSTALLATION OF CORKSPORT DOWNPIPE

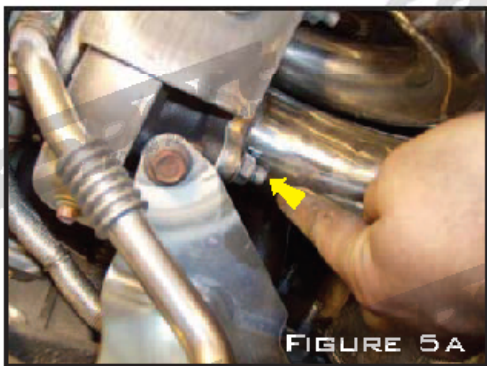

FIGURE 5A

A. FROM THE BOTTOM OF THE CAR INSTALL THE NEW CORKSPORT DOWNPIPE ONTO THE STUDS OF THE TURBO WITH THE ORIGINAL OR NEW BASKET. PUT SOME ANTI SEIZE ON THE STUDS TO MAKE INSTALLATION OF THE NUTS EASIER. ONCE THE DOWNPIPE IS ON THE STUDS INSTALL ONE NUT ON THE LOWER-FORWARD STUD SHOWN IN FIGURE 5A. YOU MUST INSTALL THIS NUT BEFORE TIGHTENING THE REST OR THERE WILL NOT BE ENOUGH CLEARANCE BETWEEN THE DOWNPIPE AND STUD TO INSERT THE NUT. TIGHTEN TO 39-46 FT/LBS.

B. INSTALL THE REMAINING FOUR 1 4MM HEADED NUTS AND TIGHTEN IN A CRISS CROSS PATTERN TO 39-46 FT/LBS.

C. INSTALL SUPPLIED BOLTS AND SMALL FLAT WASHERS (70MM FOR USE WITH CORKSPORT RACEPIPE, 80MM FOR FACTORY CATALYST) THROUGH DOWNPIPE AS SHOWN IN FIGURE 5C.



FIGURE 5C

D. PUT SMALL AMOUNT OF ANTI SEIZE ON THE THREADS OF THE O₂ SENSOR. INSTALL THE LOWER O₂ SENSOR INTO THE DOWNPIPE. RECONNECT THE LOWER O₂ SENSOR PLUG INTO THE WIRING HARNESS.

E. PUT A SMALL AMOUNT OF ANTI-SEIZE ON THE THREADS OF THE UPPER O₂ SENSOR AND INSTALL IT INTO THE UPPER PORT ON THE DOWNPIPE. REROUTE THE WIRE HARNESS AS SHOWN IN FIGURE 5E BY CONNECTING THE WIRING COIL WHICH WAS EARLIER REMOVED FROM

THE FACTORY DOWNPIPE INTO THE AVAILABLE HOLE ON THE FIREWALL. RECONNECT THE O₂ SENSOR PLUG TO THE WIRING HARNESS.

6. UNDERCARRIAGE BUTTON-UP.

A. INSTALL THE CATALYST PIPE ONTO THE DOWNPIPE ALIGNING THE NEW DOWNPIPE GASKET WITH THE INLET OF THE CATALYST PIPE AND ATTACH THE TWO EXHAUST HANGERS AS SHOWN IN FIGURE 6A. THE FIRST ONE IS EASY, THE SECOND ONE USUALLY REQUIRES BEING PRIED INTO PLACE WITH A SQUARE SHANK FLATHEAD SCREWDRIVER AS SHOWN.

B. USE THE SHORTER 70MM LONG HEX BOLTS IF INSTALLING THE FACTORY CATALYST PIPE, AND LONGER 80MM LONG HEX BOLTS IF INSTALLING AN AFTERMARKET RACE PIPE AS SHOWN IN FIGURE 6C.

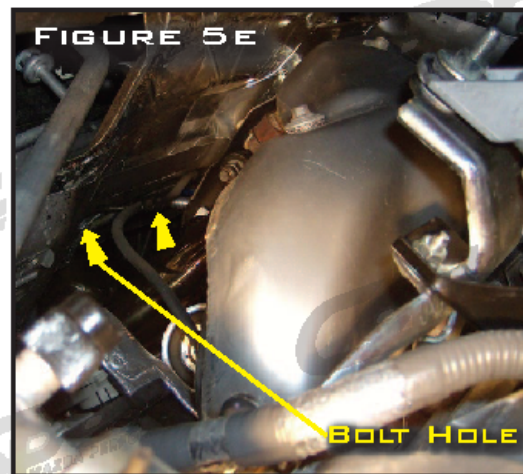

FIGURE 5E

BOLT HOLE

INSTALLATION INSTRUCTIONS: CORKSPORT POWER SERIES DOWNPIPE 2010+ MAZDASPEED3

6. UNDERCARRIAGE BUTTON-UP (CONTINUED).

B. (CONTINUED), TIGHTEN THE NUTS SO THERE IS APPROX A 1 MM GAP BETWEEN THE SPRING COILS AND INSTALL THE SECOND SET OF NUTS OVER THE BOLTS. TIGHTEN THE PRIMARY AND SECONDARY NUTS RELATIVE TO EACH OTHER TO LOCK THE SETUP.

C. INSTALL THE FACTORY FASTENERS BACK INTO THE REAR FLANGE OF THE CATALYST PIPE AND TIGHTEN TO 1 MM SPRING GAP.

D. REINSTALL THE FRONT CHASSIS BRACE (4X 1 4MM HEAD HEX BOLTS, 2X 1 4MM NUTS, 1 X 1 0MM). TORQUE THE 1 4MM BOLTS & NUTS TO 22-28 LB FT. TIGHTEN THE 1 0MM HAND TIGHT (~1 0 LB FT).

E. REINSTALL CENTER CHASSIS BRACE (8X 1 2MM BOLTS) AND TORQUE TO 22-28 LB FT.

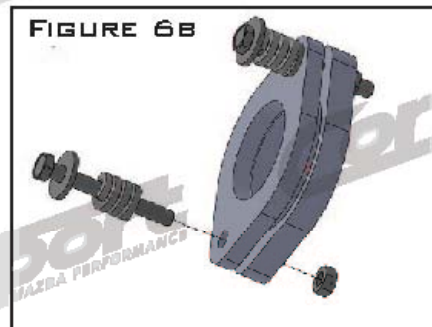

7. UNDER HOOD BUTTON-UP.

A. REINSTALL THE LOWER AND UPPER EXHAUST MANIFOLD HEAT SHIELDS USING A SMALL AMOUNT OF ANTI-SEIZE ON THE FASTENERS. TORQUE THEM HAND TIGHT (1 0 FOOT POUNDS) IT MAY SMELL A LITTLE AS THE INITIAL AMOUNT BURNS OFF, BUT YOU'LL THANK US IF AND WHEN YOU EVER NEED TO TAKE THEM OUT AGAIN.

B. REINSTALL THE INTERCOOLER INTO THE HOT AND COLD CHARGE COUPLERS AND OVER THE MOUNTING STUDS. TIGHTEN COUPLER HOSE CLAMPS AND PULL ON INTERCOOLER TO TEST TIGHTNESS OF FIT. IF THE INTERCOOLER CAN PULL OUT OR MOVE, IT'S NOT TIGHT ENOUGH. INSTALL 1 2MM NUTS OVER STUDS AND TIGHTEN TO ~20 FT LB OF TORQUE.

C. INSTALL RECIRCULATION VALVE HOSE AND REINSTALL HOSE CLAMP. INSTALL RECIRCULATION VACCUM LINE AND REINSTALL HOSE CLAMP.

D. INSTALL INTERCOOLER COVER,  ENSURING THAT THE CLASP IN THE BACK IS FIRMLY LATCHED OVER THE FEATURE ON THE INERCOOLER AND REINSTALL TWO 1 0MM HEX HEAD BOLTS. TIGHTEN TO HAND TIGHT. **DO NOT OVERTIGHTEN.**

B. TEST RUN & LEAK CHECK

A. BRING THE CAR DOWN OFF THE JACKSTANDS AND START THE CAR. USE A FLASHLIGHT TO CHECK UNDER THE CAR TO ENSURE THAT NO VISIBLE EXHAUST IS LEAKING AND LISTEN FOR LEAKS (USUALLY A WHISPERING TICK SOUND AT THE FLANGE. LOOK AT THE TWO CONNECTIONS THAT YOU MADE UNDER THE VEHICLE AND ALSO AT THE TURBOCHARGER. IF THERE ARE LEAKS, 99% OF THE TIME A FLANGE HAS BEEN OVERTIGHTENED OR IS MISALIGNED.